

Lviv State University of Physical Culture named after Ivan Boberskyj

Department of shooting and technical sports

Subject

*"Theory and Methodology of the Selected Sport
and Improvement of Sports Skill – archery"
for 4 courses students*

LECTURE:

"EQUIPMENT & FACILITIES IN ARCHERY"

by prof. Bogdan Vynogradskyi

Lviv – 2020

EQUIPMENT & FACILITIES

9.1. PRELIMINARIES

For an archery course to be successful, there are certain items that must be available, in good condition and ready for each lesson.

The coach must have the knowledge to properly set up and maintain the equipment throughout the program.

The coach must also progressively introduce and explain the equipment to the novices. Take care to not overburden them with too much information at once.

Since a certain proportion of athletes are left handed, about 20% of the available equipment should be for those who will shoot left handed and the rest for the right handed archers in the group. In some countries, and among some ethnic groups, this percentage has to be strongly modified.

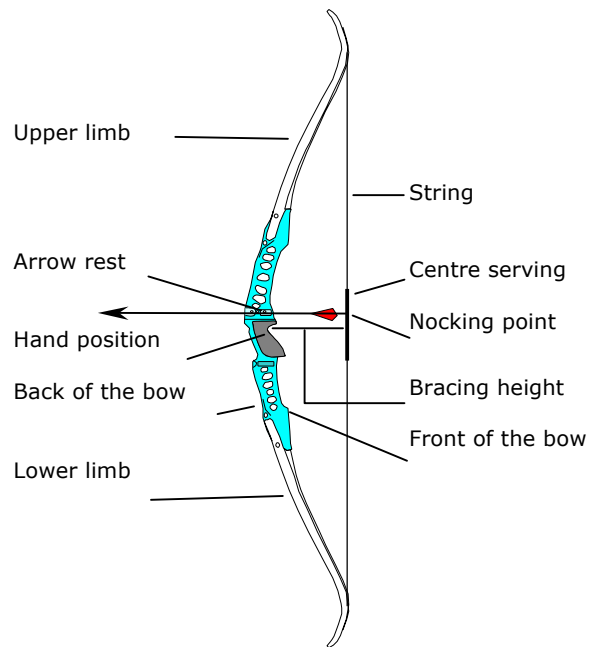

9.2. SHOOTING SIDE

Since some shooting accoutrements are specific to the shooting side, each novice's shooting side should be identified before selecting their equipment. The shooting side can be selected either according to dominant eye or by dominant (preferred) hand. However the shooting side is selected, be sure that the novice can aim with the eye on that side. This means that either the eye dominance matches the shooting side, or the archer can close the non-aiming eye without interfering with the shot. In a pinch, an eye patch can be used to cover the non-aiming eye. See chapter 4.2.4.1. [Shooting side choice](#)

9.3. THE BOW

9.3.1. Bow description:

Refer to the illustration below while introducing the various parts of the bow to the novices.

Most modern entry-level bows are takedown recurves – i.e. the limbs can be removed from the riser and used in a right or left handed riser.

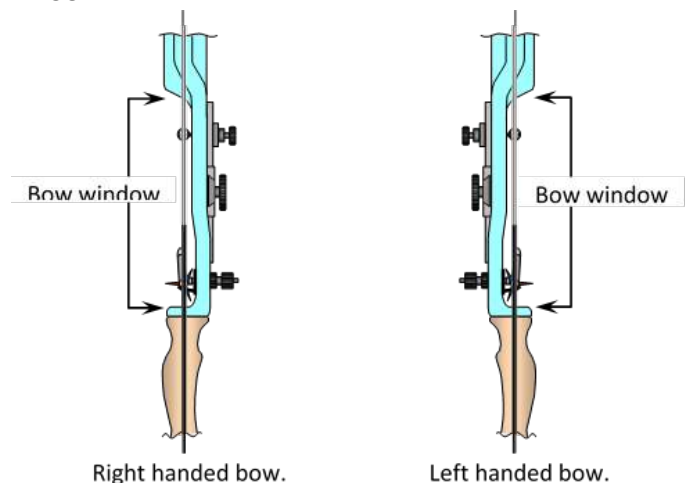

The risers are mainly manufactured for one shooting side only, though some manufacturers do make ambidextrous bows that can be used by both right handed and left handed archers. The obvious advantage of the ambidextrous bows is offset by some significant issues. For example, a riser with two windows above the bow hand may bend due to the thin material between these two windows. Another common issue is difficulty in properly aligning the arrow in the centre of the bow.

Ideally each novice will be assigned to his or her own bow for the duration of the session or program. However, it is also acceptable for two compatible novices to share a bow.

9.3.2. Bracing/Stringing a bow:

Stringing a bow should always be done using a proper bow stringing tool to ensure the safety of both the person and the equipment. The most common bow stringing device is pictured below and is available from most archery shops.



There are several other bracing methods, but we recommend these as the simplest and safest for novices.

9.3.3. Brace height (also called string height):

A bow's brace height is measured from the deepest part of the bow grip to the string or from the string to the pressure button. Always check the manufacturer's recommendation to ascertain the correct measurement for the bow being used. If the information is not available, use the brace height chart below as a guide.

Bow Height	Brace Height range	Brace Height (cm.)
64 inches	19,7 -22,9 cm	21,5 cm
66 inches	20,3 - 23,5cm	22 cm
68 inches	21 - 24,1cm	22,5 cm
70 inches	21,6 - 24,8cm	23 cm



A simple loop of rope is much cheaper, convenient and safe as shown below. Note that when using this type of bow stringer, you must protect the limb tip that presses into the ground. A small rubber disk or a foam or leather pad will suffice to prevent damage to the limb tip.

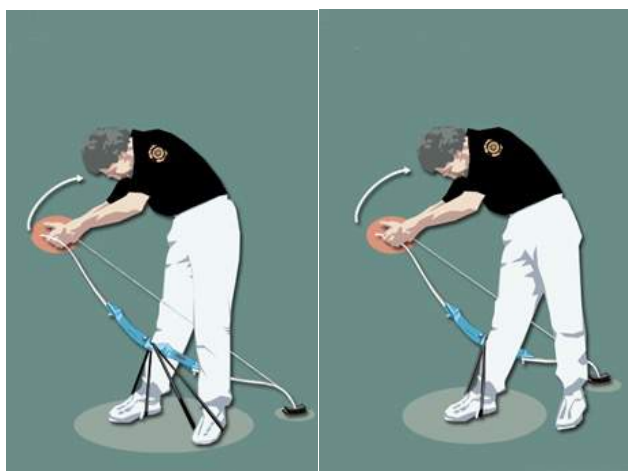

In a permanent archery range there may be a "bow bracer" like the one pictured below fixed to a wall or a pillar.

Train the beginners to periodically check the brace height of their assigned bow. They should make sure it is the same or still within the range as strings, especially those made of Dacron, stretch and change over time. Also, twists may be unintentionally added or removed if the string is taken off the bow for storage or transport.

An excessively high bracing height will not be good for the bow and will shorten the power stroke, effectively reducing the power of the bow. Alternatively, if the bow is used with the bracing height too low, the bow will be unstable and the string will, more than likely, strike the archer's wrist. The bracing height can be adjusted by adding or removing twists in the bow string. Adding twists to the string reduces its length which in turn increases the bracing height. Removing twists lengthens the string, which in turn decreases the bracing height.

9.3.4. Bow length:

Bows come in different lengths, the most common lengths for recurves are 66 inch and 68 inch. Bows of these lengths can accommodate most novice archers. The 66 inch bow would be for those using arrows up to 27 ½ inches in length, and 68 inch bow would be for those shooting arrows for 27 ½ inches and more. The following chart shows a bow length suggestion for different draw lengths of the novice.

Novices Draw length	Bow length
Up to 18"	48"
18" to 20½"	52" (or longer)
20½" to 23½"	62" (or longer)
23½" to 25½"	64" (or longer)
25½" to 27½"	66" (or longer)
27½" to 29½"	68" (or longer)
29½" to 31"	70" (or longer)
More than 31"	72"

If a short bow is selected for a novice who has a long draw length the limbs will bend more than they are designed for and may even break if they are drawn beyond their limit. Also, the string will make a sharp angle at the point of draw and could pinch the fingers of the novice reducing the efficiency of the release. The illustration below shows the angle of the string for long and short bows drawn to the same draw length.



A bow that is too long for an archer that has a short draw length will not be very efficient because the recurves aren't opened enough. This would cause the arrow to drop more quickly, necessitating that the sight block be placed lower down the sight rack when longer distances are being shot and it could be harder to aim.

9.3.5. Bow weight:

Bows come in different draw weights, some are adjustable and some are set to predetermined poundage. Select a bow for each novice that is appropriate for their age and physique.

The chart below suggests bow weights based on normal age and gender ability levels, but be sure to account for each novice's specific needs.

Gender	Age - years	Bow weight (max.)
Children	6 to 8	Up to 10 pounds
Children	8 to 12	Up to 12 pounds
Girls	12 to 14	12 to 16 Pounds
Boys	12 to 16	14 to 18 Pounds
Girls	15 to 17	15 to 18 Pounds
Boys	15 to 17	16 to 20 Pounds
Women		16 to 20 Pounds
Men		18 to 22 Pounds

Through practice, the novice will be able to progress to a heavier bow. Do not increase the draw weight of the novices bow too soon, and never increase the bow weight more than two pounds at a time. The following chart shows a test that can be used to check the "archery strength" of an archer:

Time in seconds	Action
1	Start elevating the bow
2 - 7	Complete opening the bow
8	Relax the bow down
9 - 10	Get a rest

The novice should be able to do the above 8 times without loss of form. If the novice can do this 10 or 12 times without any loss of form consider increasing the bow weight by 2 pounds.

It is sometimes possible to slightly change the bow weight of bows that are not fitted with a system of weight adjustment. Usually such bows have the limbs fixed to the riser with a large bolt. To adjust the weight, insert a piece of hard wood or plastic, approximately 1 to 2 millimetres thick, into the limb pocket to change the angle made between the limb and the riser.

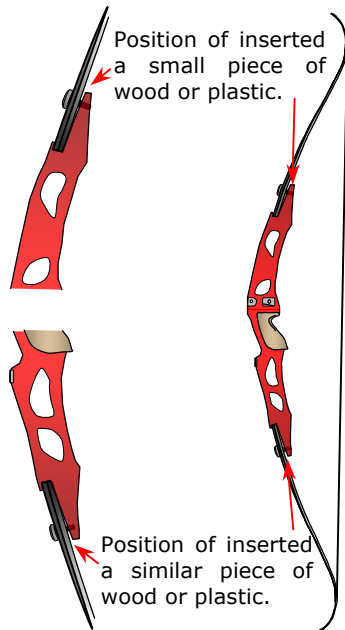

To keep the limbs balanced, a piece of the same thickness must be inserted in both the top and bottom limb pockets. By fitting these similar pieces of wood or plastic the bow will be made heavier. Be careful not to make the inserted piece too thick and always ensure there is enough of the fixing bolt threaded into the riser for safety.

Calculating Draw Weight:

The actual draw weight an archer achieves at full draw depends partially on their draw length as well as the marked weight of the limbs on their bow.

The Archery Trade Association (ATA) uses a standard measurement of 28 inches of draw length for determining the draw weight marked on limbs. The 28 inch length is defined as the Draw Length to Pivot Point (D.L.P.P) plus 1 3/4 inches. The D.L.P.P is the distance from the throat of the nock to the point on the riser directly above the pivot point of the grip. This method is depicted in the following illustration.

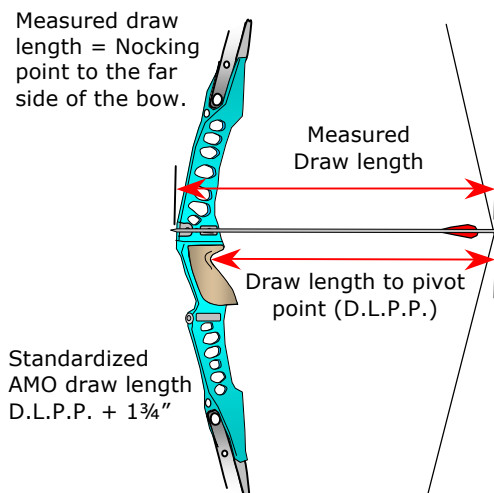

If an archer draws the bow less than the standard as shown above the draw weight will be reduced by 1½ to 2 pounds per inch of draw length difference. Conversely, if the archer draws the bow more than the standard shown above the draw weight will be increased by 1½ to 2 pounds per inch of the increased draw.

9.4. ARROWS:

9.4.1. Arrow description:

Refer to the illustration below to explain the parts of the arrows i.e. nock, point and fletchings etcetera. You must also tell the beginners how the arrows must be treated and carried to avoid any injury as the points and nocks may be quite sharp.



9.4.2. Arrow material:

The shaft of the arrow can be made of wood, fiberglass, aluminium, carbon and at advanced levels a combination of aluminium and carbon. Because wooden arrows break easily and fiberglass arrows are heavy, aluminium arrows and carbon arrows are the most popular at the entry level. Both have advantages and disadvantages.

Aluminium arrows are considered to be stable and forgiving, but they are a little heavy and slow. Also, they can bend, particularly the light ones used with light entry-level bows, when pulled out of the target by the novices.

Carbon arrows are lighter, faster, and cannot be bent. If the carbon fibres are straight, they crack easily and can become dangerous. Nowadays there are many models made with crossed carbon fibres that are very resistant. Avoid nocks that fit on the outside of carbon arrows. If the arrows are improperly matched with the bow weight, they often hit the arrow-rest or even the bow window upon exit.

Be aware that if carbon arrows are used, all arrows that miss the target must be found before leaving the field. This is critical if the field is a multi-use sports field as broken carbon shafts can cause significant injury to the others using the space. Carbon arrows that do not have a metal core cannot be found using a metal detector unless the metal point is of a sufficient size that the metal detector is able to locate it.

9.4.3. Arrow identification:

Many arrow shafts look the same in most respects, especially to beginning archers. Thus it is important have a selection of arrows that are distinctive enough to be told apart by novices. The most common method for this is to have a set of arrows with a unique colour combination of fletching and nocks for each archer.

It is usual to have three fletchings on each arrow 120 degrees apart, with the cock fletching a different colour than the other two for easy recognition by the novice.

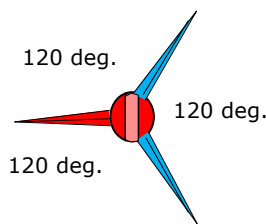

Use larger fletches or vanes for stability and to slow down the arrow flight for easier arrow finding should they miss the target. The recommended length of fletching or vanes is $2\frac{3}{4}$ " , or a little longer (up to 3").

A more advanced and time consuming method of making the arrows identifiable in groups is a process called "cresting." Cresting arrows involves creating bands of colours around the arrow shaft. Using unique patterns of colours makes the arrows different enough to be told apart from one another.

9.4.4. Arrow Length:

Please refer to section 4.2.4.2. "Determining draw and arrow length" for a description of how to ensure that arrows are a safe length for each archer.

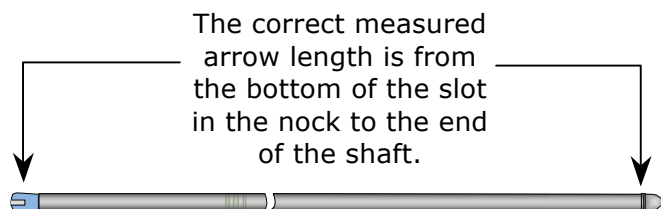

Arrows are usually left uncut for safe usage by novices having varying draw lengths. An uncut arrow will often be 29 inches or more. While not optimal for performance, an archer can always safely shoot an arrow that is longer than his or her draw length. Also in this way a stiffer spined (*), and therefore more robust, arrow may be used to give a longer life span.

(*) See the following section for the definition of spine

For taller archers needing longer arrows, carbon arrows should be considered since long aluminium arrows are too stiff for light draw weight bows. The lightest available spine for a 32" draw length, for example, is a 1916. Such a stiff arrow would not fly well out of a bow with a light enough draw weight for novices.

9.4.5. Arrow Spine and Size:

Arrow shafts have different spines. The spine is a characteristic close to flexibility. There are two standards to measure the spine of an arrow.

The ATA (Archery Trade Association) Standard:

When measuring arrow spine rating an arrow of 29 inches is used, this is placed on two points 28 inches apart and a weight of 880 grams (1.94 lbs.) is hung in the middle. A dial gauge measures the movement from the home position of the arrow to the position now reached with the weight suspended. This measurement is calculated in 1,000ths of an inch to give the static spine rating of this particular arrow. I.e. an arrow that deflects a $\frac{1}{2}$ inch (0.5 of an inch) will have a static spine rating of 500 and an arrow that deflects $\frac{3}{4}$ inch (0.75 of an inch) will have a static spine rating of 750.

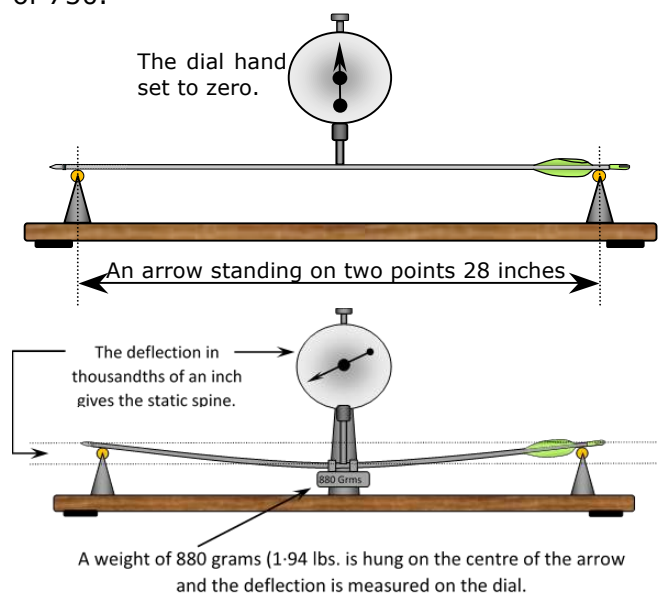

Be aware that some of the lighter (weaker) spined arrows are spined at 26 inches, also some manufacturers of wooden arrows use a static spine set at 26 inches.

The spining method as used by an Asian arrow making company:

An arrow manufacturing company in Asia uses metric measurements, and as such the numbers written on their arrows do not correspond to the ATA system, so care must be taken to ensure you are selecting the right arrows when making a purchase from companies that do not use the ATA system to spine their arrows.

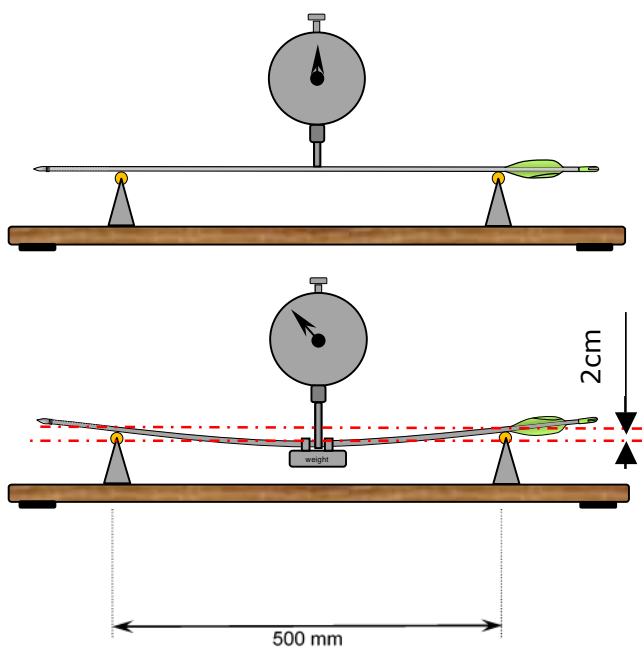

For this Asian company’s the spine is determined by the weight required to deflect the shaft by 2cm with the shaft supported at points 500mm apart. The arrow is then given an identification to suit this finding. See table below.

Shaft number	Outside diameter (mm)	Weight for spine (kg)	Straightness per inch	Weight Grains/inch	Shaft length (inch)
1100	4.44	1.9	± 0.001	5.82	28.0
1000	4.52	2.1	± 0.001	6.14	29.0
900	4.76	2.4	± 0.001	6.36	29.5
800	4.79	2.5	± 0.001	6.56	30.0
700	5.25	3.0	± 0.001	6.80	31.0
600	5.32	3.2	± 0.001	7.14	32.5
500	5.38	3.6	± 0.001	7.49	33.0
400	5.54	3.8	± 0.001	7.88	33.5
300	5.65	4.7	± 0.001	9.03	34.0

A carbon arrow with an ATA spine around 1200 fits many beginners (if it is long enough), while a 1716 is recommended as the usual aluminium arrow for novices.

The numbers used to differentiate aluminium arrows are often different from the spine value of the arrow. They are useful, however, in indicating the relative stiffness and strength of the shafts in question. The arrow shown below using the ATA standard is a 1716. The tube diameter is 17/64ths of an inch with a wall thickness of 16 thousandths of an inch, e.g.1716.

Tube diameter, e.g. 17 thousandths of an inch

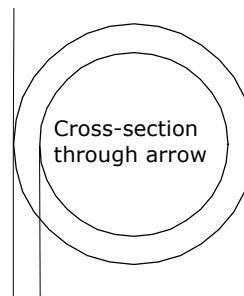

Wall thickness e.g. 16 thousandths of an inch

Be aware that the aluminium arrow is stiffer, heavier and slower. Also, whereas it is considered as more forgiving than the carbon shafts, it can take a permanent bend. 1716s can be loosed with reasonably straight flight with the lower weight bows used if left at the full uncut length of about 29". The more suitable 1616 will be quite fragile for general beginner use.

9.4.6. Arrow assembly & maintenance

9.4.6.1. Fitting the nock:

It is recommended that arrows be bought full-length. The shop will install the nocks if asked but you can fit them yourself if you wish to do so. Put a small amount of fletching glue on the swaged end of the arrow then fit an appropriate sized nock, twisting it a little to spread the glue around the swaging.

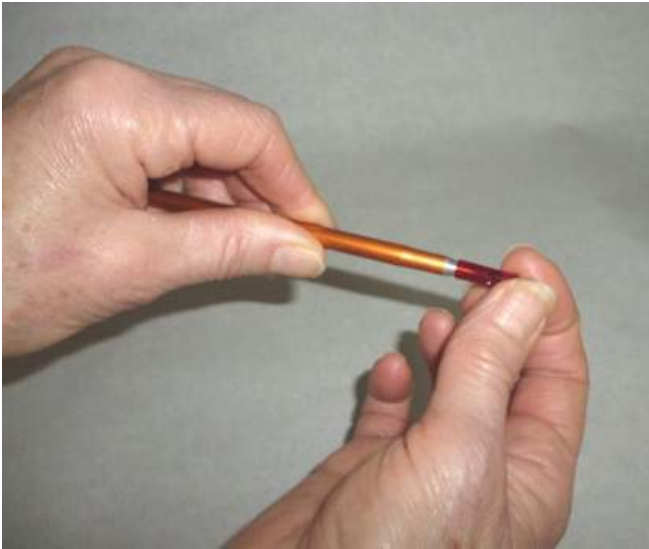

9.4.6.2. Installing the point into an arrow:

The next task is to fit the point. The shop will install the piles if asked but you can install them yourself if you wish to do so.



To do this you will need a small flame and some "warm melt" glue.



Warm the point of the arrow in the flame whilst holding the point with the fingers; only minimal heat is required. If the point is too hot to hold by hand, the heat may damage the front of the arrow when the point is inserted.



Rub some of the warm melt glue around the insert part of the pile and put a small ring of glue in the end of the arrow. Insert the pile into the end of the arrow with a slight twisting action until the shoulder on the pile fits up against the end of the arrow.



Should it be necessary to remove a pile, heat the point of the pile, not the arrow shaft. Then hold the pile in a pair of pliers and remove with a slight twisting action.



9.4.6.3. Fletching the arrow:

Now it is necessary to fit the fletchings. There are a few items needed to do this, including:

- A fletching jig
- Fletchings of choice
- Fletching glue
- Acetone and a clean cloth

Fletching jigs come in many varieties, some hold one fletching at a time while others hold three fletchings at a time. Versions of these jigs are pictured below.

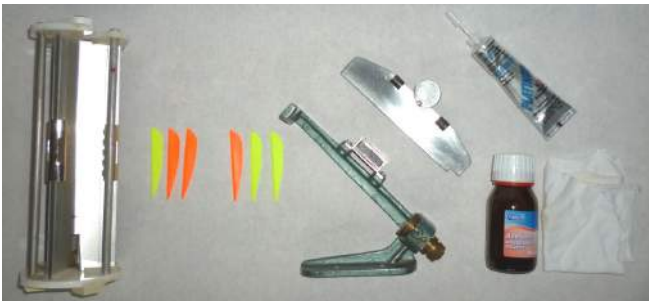

To fletch an arrow, first put it into the fletching jig, making sure that the nock is well seated. Secondly, place the chosen fletching in the clamp. Most fletching clamps have some mark like a cut-out for lining up the back of the fletching. Clean the gluing edge with a clean cloth dampened with acetone. Put a thin layer of glue along this edge and put the clamp in the fletching jig with the glued edge of the fletching pressing against the arrow.



Wait the recommended time for the glue to dry enough to hold the fletch in place. When the glue is set, remove the clamp and turn the dial at the nock end of the jig to another position (120 degrees) and repeat the process until all fletchings have been glued to the arrow.

Make sure while fletching that the cock fletch is properly aligned with the nock. Most fletching jigs have an indicator to show where this alignment occurs.





The fletching jig above shows all three fletchings being fitted at one time. Having a fletching jig such as this greatly reduces the time required to fletch a set of arrows.

When all three fletching have been fitted put a little bead of glue to the front and rear of each fletching where they meet the arrow shaft. This helps reduce the chance of the fletchings coming off should they miss the target and land in the grass.

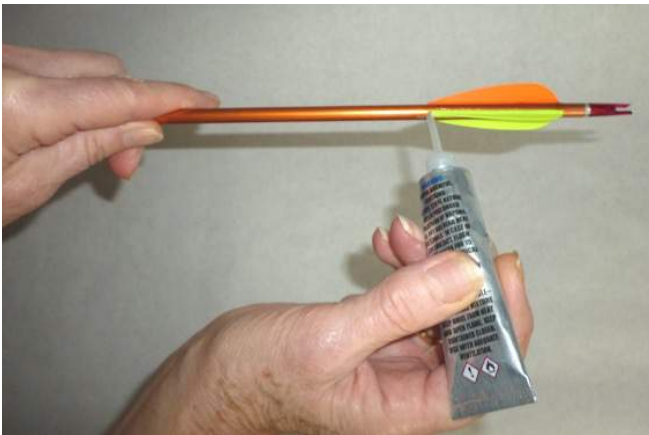

9.4.6.4. Checking the straightness of the arrow:

To check the straightness of the arrow, the suspect arrow can be laid and spun on another arrow. If the arrow is bent it will wobble and possibly make a vibrating noise.

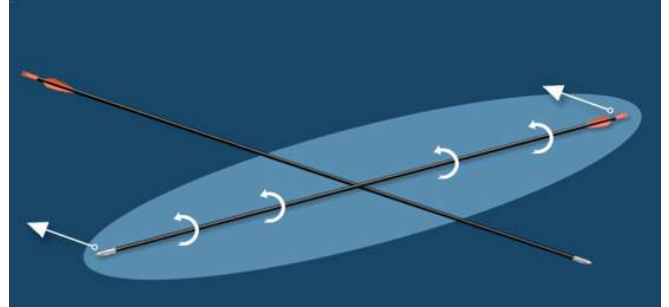

If the arrow is bent, an arrow straightener will enable aluminium arrows to be straightened. There are several models of arrow straightener available commercially. Do not try to straighten carbon arrows as these will break and may cause injury if care is not taken.



If a carbon arrow is suspected of being damaged the following steps may help. Take hold of both ends of the arrow, twisting one end one way and the other end in the opposite direction. Then reverse the twisting action. If there is some damage you should be able to hear the carbon fibres rubbing on each other as the arrow twists. If this sound is heard discard the arrow as they are not repairable. Be careful when conducting this test. In fact it is advisable to wear good strong gloves and protective eye shields.

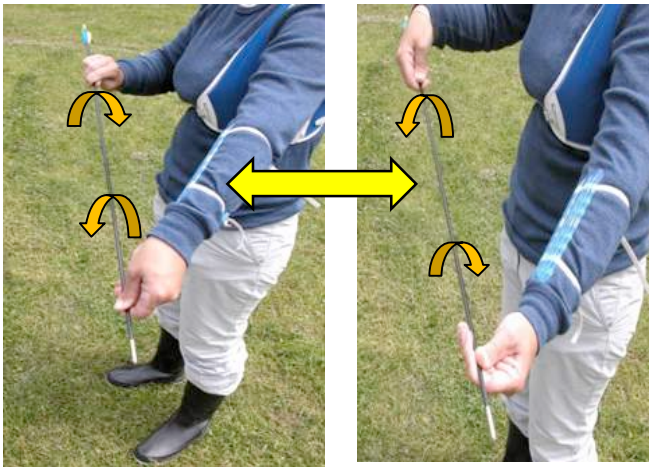

Checking a carbon arrow for damage.

Reminder:

A minimum of six arrows per novice are recommended

9.5. TAB

Using a finger tab is the most popular way to protect the string fingers from the friction of the string. There are many types of tab on the market and as the novice develops they will try many and then settle on one that suits them.



Differing types of finger tabs.

Many archery coaches do not introduce any finger protection right away in order to be able to check the proper string grip of the novice. When it is introduced, explain that the tab protects the fingers from any possible soreness or abrasions that the string may cause if one is not used. Also it allows for a smoother release of the string which produces better arrow flight and better arrow grouping.

Most beginners will start with a basic tab made from one or two pieces of leather and then may progress to a shelf tab with a finger spacer and possibly even a palm plate and/or fourth finger rest.

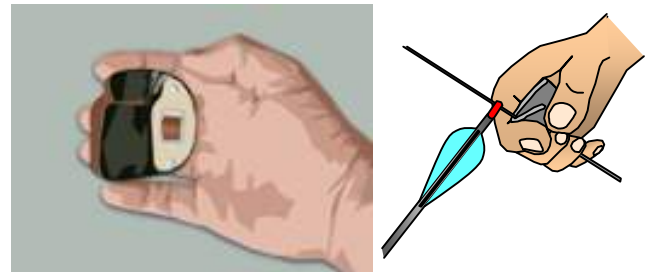

9.6. ARMGUARD (bracer)

An armguard is an essential part of a novice's kit and is mandatory for the first shots in order to minimize the risk of pain or injury to the novice. Show the class an armguard and how they are fitted. Explain they are worn to protect the forearm should the bow string inadvertently touch the arm during the shot and to keep any clothes away from the path of the string when the shot is made. There are many types of bracers on the market and as the novice develops they will try many and then settle on one that suits them.

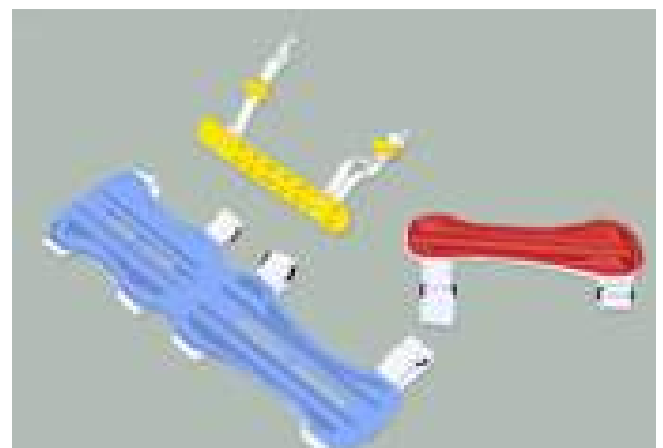
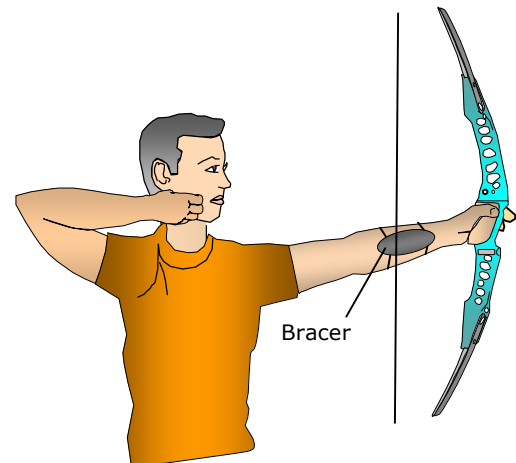

Different types of armguards (bracers).

9.7. WRIST/FINGER SLING

A sling helps the archer to keep a relaxed bow hand and avoid the bow from falling to the ground upon release. There are two popular types of slings on the market. A "wrist sling" is attached to the archer's wrist, while a "finger sling" (the most popular type) usually fits between the forefinger and thumb. A sling mounted on the riser is not recommended.



Wrist sling Finger sling



The hybrid Wrist-Finger sling is also an alternative

It is advisable to wait for the second lesson before introducing a bow or finger sling to the novices. If they are introduced to a wrist sling or finger sling on the first lesson it may confuse them with all the other things they have to remember.

The wrist sling or finger sling should be loose enough to allow the bow free movement when the shot is made but not so loose that the bow slips out of the hand.

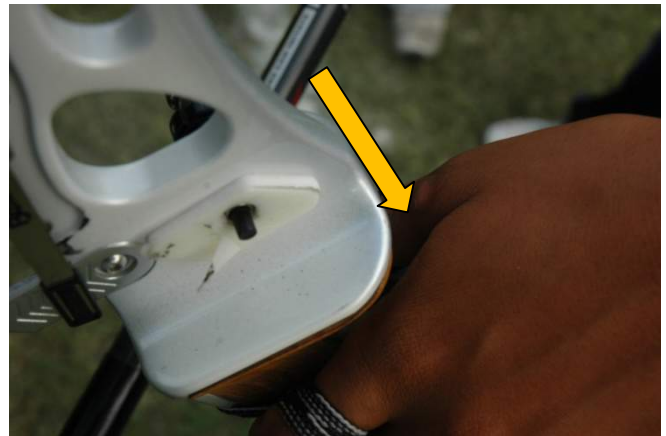

With a sling that is too long the novice tends to close the hand upon the release to avoid the bow slipping down between the string and the bow-hand.

9.8. QUIVER

It is advisable for novices to use a quiver so that the arrows are in a safe place prior to shooting them. There are many types of quiver available, including belt quivers (shown in the next illustration), back quivers that hold the arrows above the archer's head or shoulders, bow quivers that are attached to the riser, pocket quivers that fit in a hip pocket and ground quivers that rest on the floor. As the novices develop, they will select the one that best suits their needs. Two types of quivers are suitable for group instruction: the belt or side quiver, and the ground quiver.

Beginners with belt quivers quite often jab other archers with nocks because a beginner isn't accustomed to having sharp sticks swinging off their bodies. Depending on what the novice is wearing, a quiver-specific belt maybe required. Basic belt quivers can be made to act as either left or right-hand by reversing the hook. They are suitable for indoor and outdoor shooting. This type of quiver avoids the beginners coming back from targets with arrows in their hands; a significant safety benefit.

Ground quivers come in two different types, indoor and outdoor. The indoor types have a flat base that does not mark the floor and is heavy enough to support the arrows upright. The outdoor type has a metal spike on the bottom so it can be driven into the ground to prevent the wind from tipping it over. Some ground quivers also serve as bow supports and have two curved prongs at the top to rest the bow. Floor quivers should be placed on the shooting line about 30 cm in front of the archer. There are five disadvantages to using a ground quiver:

- coming back from the butt to the shooting line archers must carry their arrows in their hands, which can be unsafe;
- they must be moved when moving the shooting line;
- it increases the space required per archer on the shooting line;
- two are required, one for indoor and outdoor; and
- they must be placed in exactly the same place each session to facilitate uniformity of the nocking procedure during the shooting process.

On another hand the ground quiver allows the archer to more easily know where to stand while shooting. It helps them to line up with the target but they are supposed to be shooting at. In addition, they're simple to use and to make (no need for belts or clips).

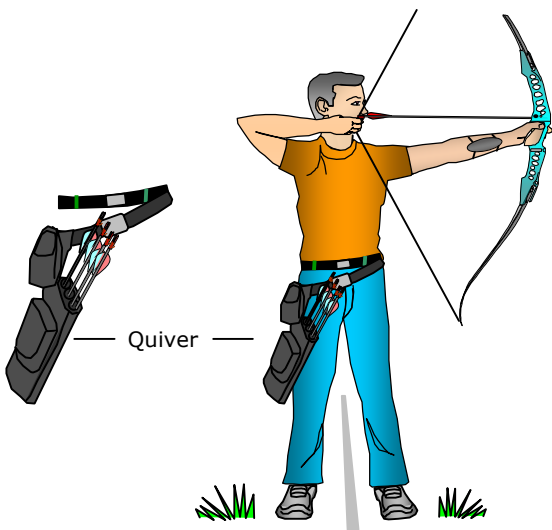

A chest guard



A simple loop of soft elastic wrapped around the arms



A band of tape keeping a loose sleeve out of the path of the string

9.9. CHEST-GUARD

When taking part in archery training sessions the archers should wear clothes that are reasonably close-fitting around the upper body and arms, though not so tight as to restrict movement. If the clothing is too loose or baggy in these areas the bowstring may snag on the clothing when the bow is shot, making the arrow deviate from its true line of direction.

The following illustrations show a chest guard in use and a piece of material wrapped around a baggy sleeve. Safety pins or some tape can also be used to keep loose clothing from the path of the bowstring.

9.10. FOOTWEAR

The sport of archery requires the novice to be on his or her feet for long stretches at a time. Consequently, footwear that both promotes a stable stance and comfort during walking is ideal. An average athletic shoe works very well. While it is possible to shoot in most any footwear, it is essential that open toed shoes are not worn on the archery field. The archer

may accidentally walk into an arrow that is sticking in the ground, having missed the target, and cause a nasty injury.

9.11. TARGET BUTT

A target butt or butts will be required; the usual height of the centre point is 130 cm +/- 5 cm from the ground. It may be advisable to have the butt lower than this for the first lesson so that any arrows that miss the target do not travel too far. For the first lesson do not use a target face as the beginners need to concentrate on their form rather than their score.

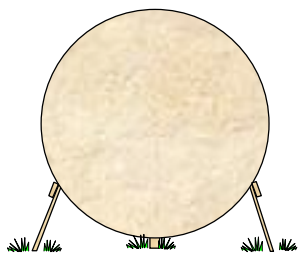

For entry level, the centre of the target butt is often set lower than the official measurement for tournaments

Use a soft material for the target mat in order to avoid the arrows bouncing back on the beginners shooting from a short distance.

For further information on target mats and stand, see pages 10 and 11 of the document entitled "How to make an Archery Range" at [http://www.worldarchery.org/Portals/1/Documents/Development/Documents/How to make an Archery Range.pdf](http://www.worldarchery.org/Portals/1/Documents/Development/Documents/How%20to%20make%20an%20Archery%20Range.pdf)

9.12. BOWSTRING

9.12.1. String description:

A bowstring is the element connecting both extremities of the Recurve and Long bow. The arrow is nocked near its middle and the archer pulls it back then releases it.

A bowstring is made by a thread twisted up several times on its length, and strengthened by servings from another strand in the potential wear points.



There are many materials for bow strings on the market but Dacron is the preferred material for beginner's bows. To ensure that the proper amount of energy is transferred to the arrow, 8 strands of Dacron is ideal, but up to 10 strands may be used. Beware when choosing a different string material as some manufacturers do not guarantee their "beginner bows" if some of these "non-stretch" materials are used.

9.12.2. Making a string:

Whatever material is being used, the basic method to make a string remains the same. Care should be taken to have the number of strands suitable for the material being used as some materials are thicker or thinner than others.

The materials and tools needed to make a string are:

- a spool of Dacron (or other material)
- serving material (usually soft twist or braided nylon)
- string server
- scissors
- 2 markers (each a different colour)
- a ruler

AND

- patience
- time
- care
- the will to make a good string, even if it means starting all over again.

Installation onto the support device:

If you already have a bowstring that is the length of the new one you are about to make it is easier to make the new one the correct length on the first try.

If you do not already have a string which is of the correct length there are procedures and measurements which will help get close to

the length of string required. This will be discussed a little later.

If you have a string that is the correct length:

Turn the string jig post carrier ends so that they are in line.

This part depends on the length of the string, but undo between 10 and 15 of the twists. Place it on, and adjust the string jig so that there is no sag on the string. Do not have the string too tight as this will have an effect on the string length that is being made. Take the old string off the jig.

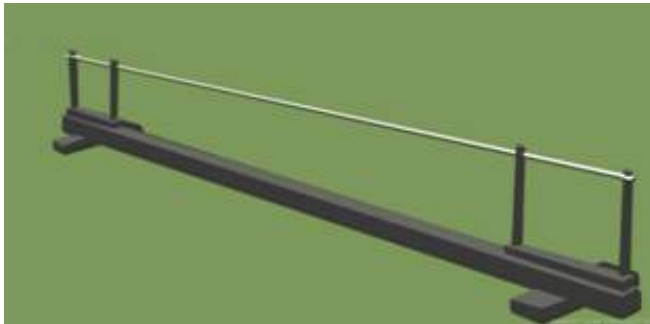

If you do not have a string that is the correct length:

Set the distance between the outside parts of the string jig to a length that is 3½ inches (9 cm) shorter than the length of the bow. This measurement depends on the make of the bow but it will bring you close to the required length for subsequent string making.

Winding the new string material:

Turn the jig ends so they are square to the line of the jig. Loosely tie one end of the string material to a string post about 2 centimetres below the groove on the post which takes the string material. Then wind the string material around the posts, keeping to the groove at the top of each post. Make sure the rotation starts by going around the post that is the nearest to the post the string material is tied to. The secret to a good, reliable string lies in the equal tension of each strand. If the tension is not equal between all strands, the string performs poorly or may even break because the pressure is held only by a few strands. As the pressure of beginner bows is always less than 25 lbs, we recommend making strings using Dacron with 8 strands.

If you are making an 8 strand string wind around the jig 4 times. For a 10 strand string, wind around the jig 5 times. Always make sure the finishing end is tied lightly to the post that is past the post to which the start of the string material was tied. This allows an overlap of the

string material to be secured under the loop serving.

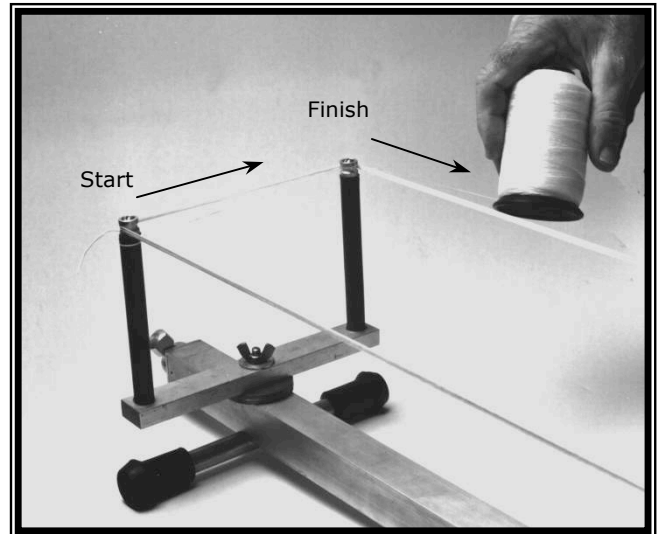

Making the first string end:

Make the first end of the string to be served the end of the jig that has the string material overlap. This will be beneficial and stop those ends coming loose as the string manufacture continues. Untie the starting end that was tied 2 centimetres down the first post and loop it round the post groove under the windings of the first string post.

Starting serving the loop:

Pass the end of the serving thread through the strands of the strand that are wound around the posts and, while holding the end of the serving thread along the string strands, serve over it for approximately 1cm. At this point cut off the excess loose serving thread and continue serving until you reach the required length that suits your limb width. All servings must be wound on the string in the same direction to ensure that they will not come loose when twists are added to the string for active use. One possible system is to always serve from right to left, having the serving tool come forwards under the string. If all servings are completed this way they will all be in the same direction.

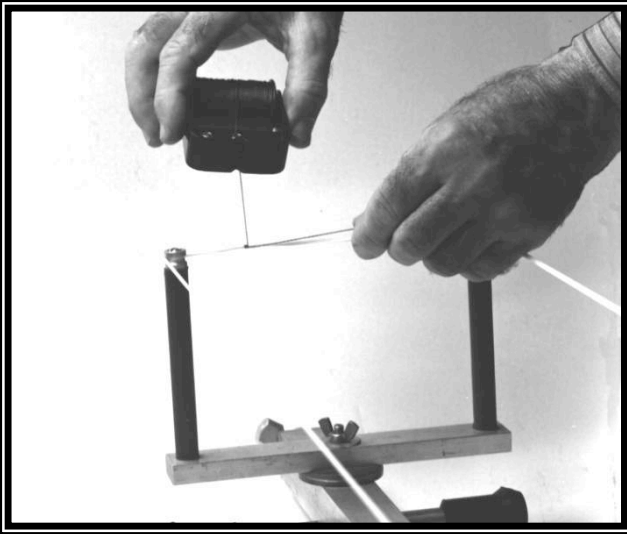

Serving the end loop

The length of serving for the loop:

How long the serving should be before it is made into a loop depends on the width of the limb over which it has to slide when stringing the bow. On most of the entry-level bows, 6 centimetres is correct for the loop on the lower limb and 8 centimetres for the upper limb. It can vary depending on the width and thickness of the limbs. Mark the end of the selected length.

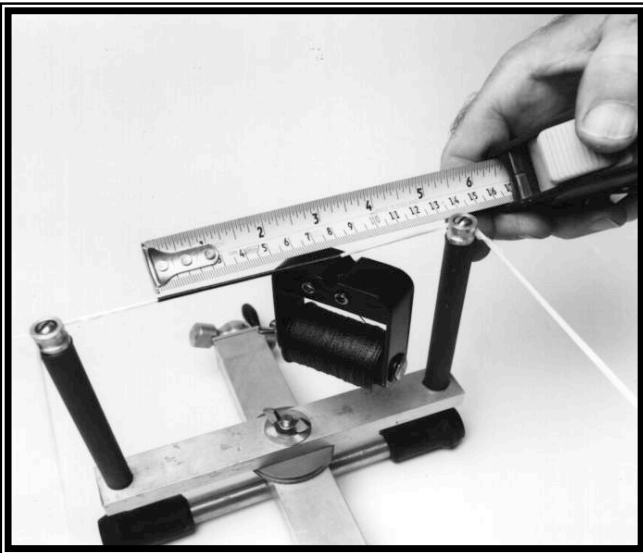

The length of the serving for the loop depends on the size of the limb tip

Creating and finishing the loop:

When the correct length of serving has been reached, untie the two ends of the wound string material, then turn the string jig posts 90 degrees. Slide the string around the jig so that the served section is now around the outside post.



When the correct length of serving has been reached, turn the string jig posts and continue to serve

Line up the two ends of the serving rather than having one overlap the other. This provides for a thinner junction area of the string, which will fit nicely into the string groove in the centre of the limb ends.

Continue serving the now-joined loop in the same direction as before. Make sure the two loose ends of the string material are held along this section and served over*. After about 6 centimetres the two loose ends should be cut off, making sure that there are at least 4 winds of serving between cutting off the first loose end and the second. This prevents the formation of a small step along the serving, which may wear and cause the serving to break during use.

(*) Because strings for entry-level bows are thin, in order to get a little more thickness under the centre serving and have a better nock pinch, you can attach the loose ends at opposite ends of the jig and have the two loose ends under the centre serving, instead of in one loop.

Serving to the correct length:

Wind the serving on to within 1 centimetre of the desired length i.e. about 10 or 12 centimetres. The exact measurement depends on the limb Recurve curvature, but it is necessary to have approximately 1cm of serving not touching the limb when the bow is at rest. Mark the end of the selected length. Keeping the tension on the serving, pull the serving tool away from the string and cut the serving thread leaving about a 40-centimetre length for finishing off the serving.

If you do not cut it, just make bigger the loop/bridge described below, in order to pass the serving tool below.

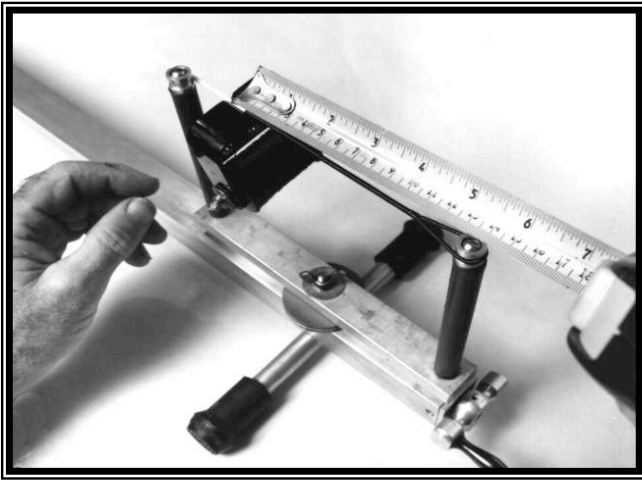

The length of the serving after the loop depends on the limb curvature

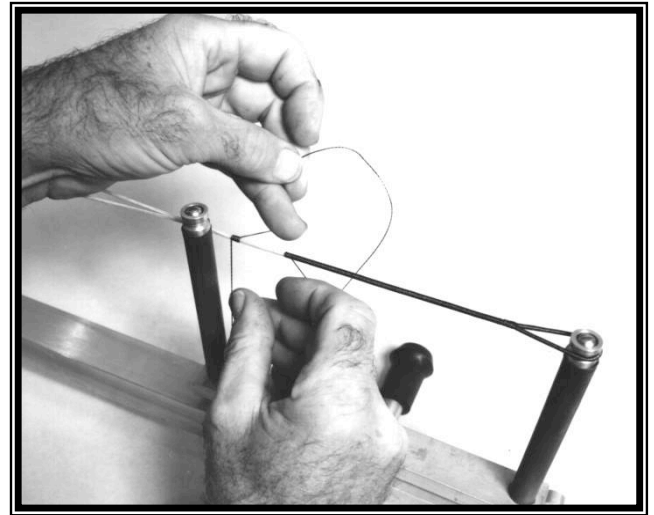
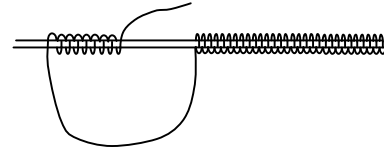

Serving manually back through the loop (under the bridge)

Making a neat end to the serving:

Make a loop or bridge with the tail end of the serving. Make sure that the two feet of the bridge are on opposite sides of the core of the string. Then wind the tail backwards around the string under the bridge and towards the loop end of the string.

Locking off the tail end:

Serve in this backward fashion for about twelve turns or until it is about 1 centimetre long. Place the tail end under the loop/bridge of serving thread just as it comes off the end of the serving already completed with the serving tool and lock it there by keeping pressure on the loop/bridge.

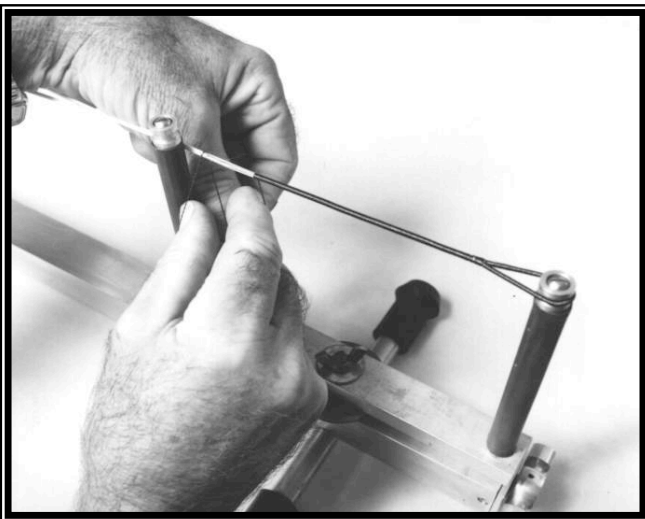

End preparation by making a loop or bridge

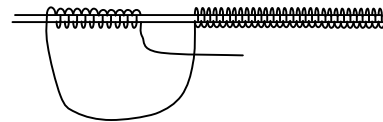

Serving back through the loop or bridge:

Continue winding the tail around the string in the same direction passing the tail end of the serving over the top of the string with the left hand to the thumb and forefinger of the right hand, bringing it through the loop/bridge and passing it back to the left hand. This part of serving will be running through the loop/bridge and toward the serving already done with the serving tool. This can also be done leaving the serving material still attached to the serving reel and passing the serving reel through the loop/bridge.

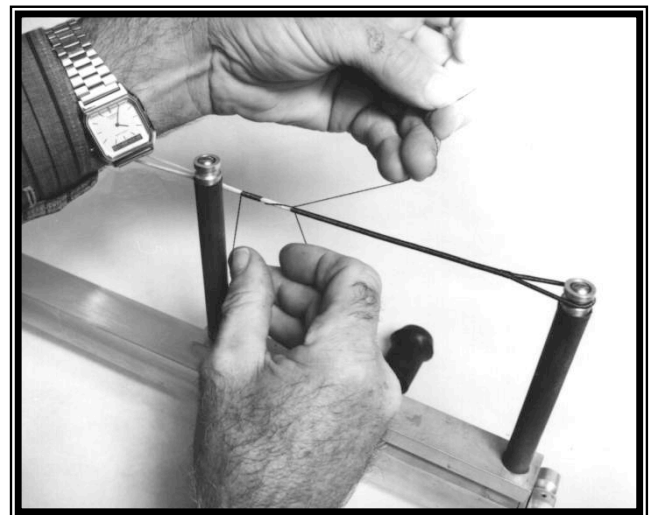

Serve back at least one centimetre and secure the tail end

Finishing off the serving:

Once the tail end has been secured, continue on from the serving already done with the serving tool by winding the loop/bridge around the string, keeping tension on it. In this process the serving will get longer and the part that was wound through the loop/bridge will get shorter.

If the part that was wound through gets longer, it has been wound in the wrong direction. To remedy this, simply unwind the serving to free the loose end again and re-wind the section through the loop/bridge in the opposite direction.

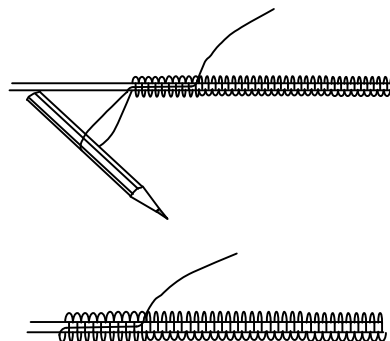
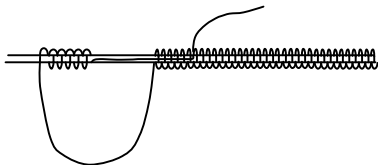

Cutting off the tail end:

When the tail end has been pulled through and the serving is nice and tight the tail end can be cut off. Use a knife placed flat on the serving furthest from the loop to cut off the remaining tail, taking care not to cut the serving wound on the string.

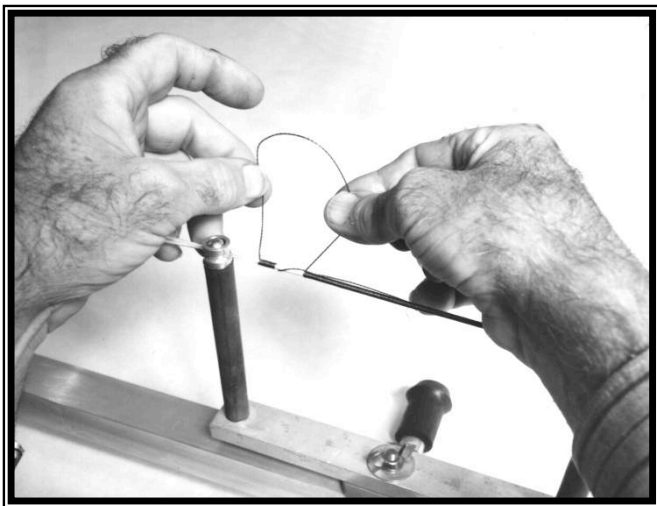

By serving the right part manually over the tail end you unserv the left part

Pulling the end through:

When all of the winds on the loop end have been undone, still keeping the loop tight, pull the tail end until the loop has completely gone. The thumb of the left hand or even a pencil can be used under the loop to maintain the tension whilst the tail end is being pulled through.

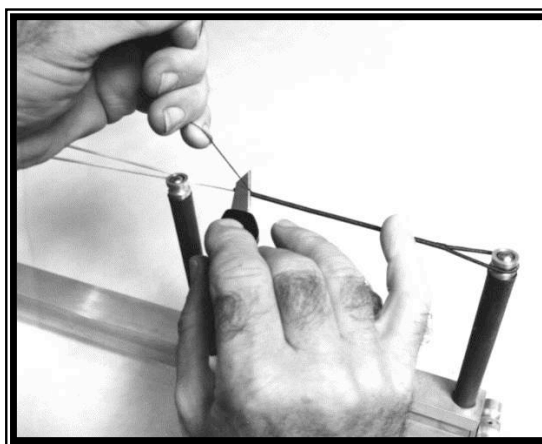

Cut off the tail end

Making the second end of the string:

When the first end of the string is complete, turn the string jig around and repeat the above steps on the other end. The loop serving must be centred between the two posts to ensure that when the loop is being formed there is no (or a very small) overlap of the ends of the serving to ensure there are no bare string fibres showing. Bear in mind that the top loop of the string must be large enough to slip over the top limb when stringing the bow.

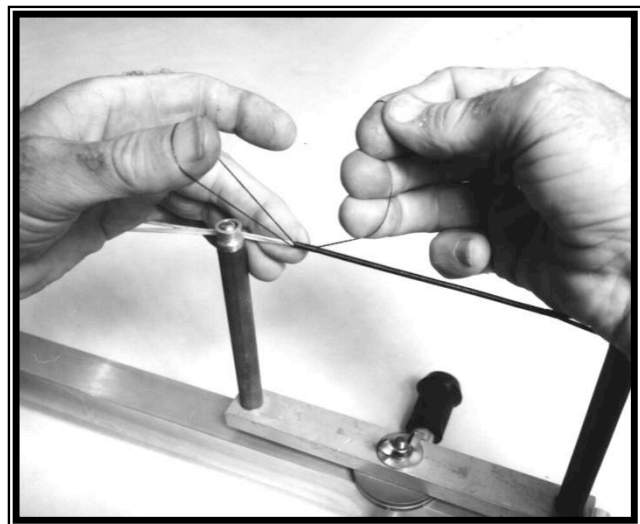

Locking off the end serving

Twisting the string in the correct direction:

When both end loops are completed, the string should be fitted to the bow so that the centre serving can be added. (It is also possible to do the centre serving on the string jig). To do this fit the top loop over the top limb and slide it down about 10 centimetres. Take hold of the loop for the lower limb and twist it for 10 to 20 turns (see next section entitled "Getting the correct Bracing Height").

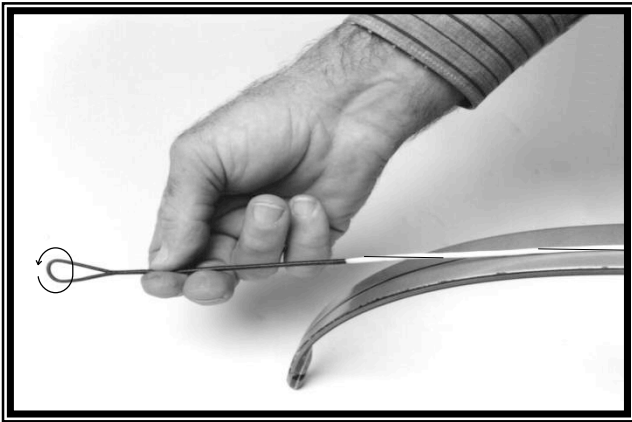

Twisting the string makes the strands unified

The direction of twist shown above is the correct direction for the direction of serving shown in this document.

If the string is twisted in the opposite direction to the serving, the serving will possibly come loose and may move during use. All three servings must be wound on the string in the same direction.

Some people serve their strings in a different direction than shown in this document. The following diagrams may help in determining the direction the string should be twisted in relation to the serving to stop any of the servings coming loose during use.

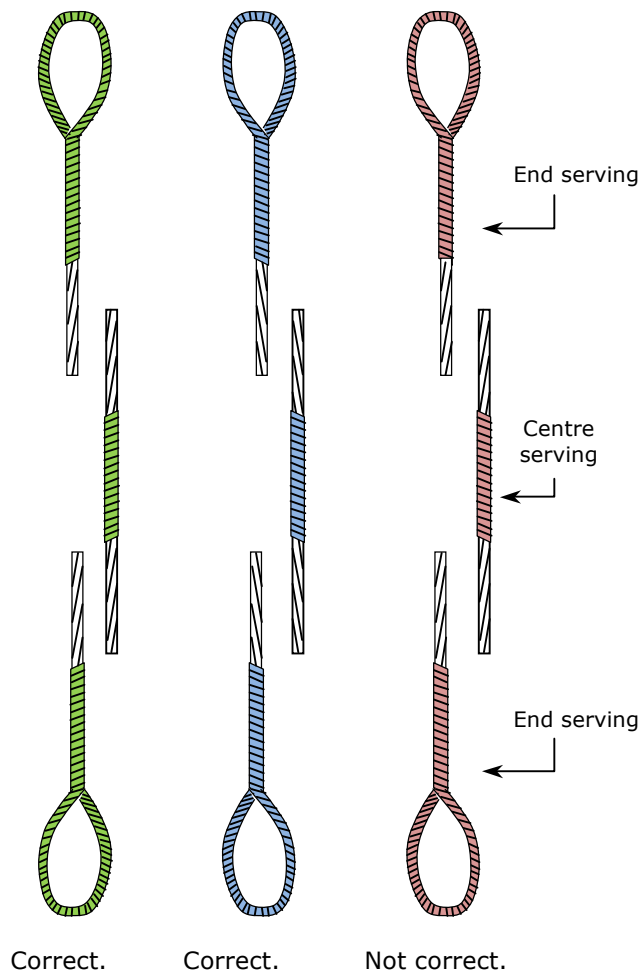

The string shown on the right is not correct as the string has been twisted in the opposite direction to the servings.

Getting the correct bracing height:

The Brace Height is the distance between the deepest part of the bow grip and the string.

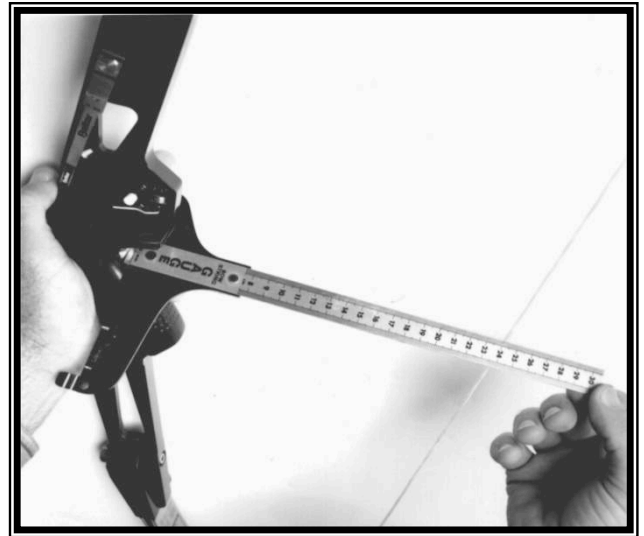

Brace height measurement

If the new string is not the correct length for a given bracing height then the length may be adjusted by adding or reducing the number of twists in the string.

Bow Height	Acceptable range	Average brace height
64 inches	19,7 - 22,9 cm	21,5 cm
66 inches	20,3 - 23,5cm	22 cm
68 inches	21 - 24,1cm	22,5 cm
70 inches	21,6 - 24,8cm	23 cm

The minimum recommended is approximately 1 full turn every 7.5 centimetres or 3 inches. While there is no maximum number of turns, remember that, the more twists in the string the longer it will take to settle to its working length. More twists also means more "springiness" in the string, resulting in decreased speed.

Bedding in the wax:

Before bedding in the wax have the brace height 3 millimetres higher than the desired final height. The bedding process increases the string's length, thus lowering the brace height. Take a piece of leather, or a Dacron strand that is also waxed and fold it around the string. Rub up and down the full length of the string to generate heat and melt the wax, bedding it into the string. Be careful not to heat the string up too much or you may damage the strands. Most string materials do not need extra wax applied to the string before undertaking this task, but if the string material is un-waxed then a few rubs

of a beeswax block on the string will be necessary before the string is rubbed with the piece of leather.

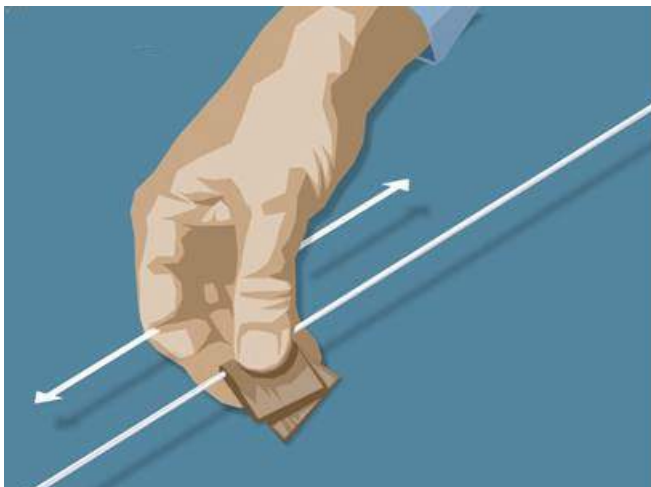

Rubbing in the wax with a piece of leather



Or with a piece of Dacron strand

Making the centre serving:

With the bracing height set to the desired height the centre serving can be applied.

Choose a serving material with a diameter to give the correct fit for the size of nocks to be used.

Mark and start the serving 4 – 5 cm above the desired nocking point position to give adequate string protection. Set the bow with the top limb on the right and remember to serve in the same direction that the end loops were served, i.e. from right to left taking the serving spool over the top of the string and away from you.

Just after the tail has come out at the start of the center check the nock fit on the serving. This will save having to build up the nocking area to get a good fitting nock or having to replace the serving because the nock is too loose or tight. See the section "Nock fit tips" further down.

If it is a little too loose, try the nock fit on the part of the serving with the tail underneath. If that fits, simply serve over the tail. If it is still too loose, remove the serving and choose a bigger serving strand or add the required number of Dacron strands where the nock will go. If the serving is slightly too thick (which is unlikely with only 8 or 10 strands), try increasing the tension on the server. Otherwise, stop, remove the serving and choose a thinner serving strand.

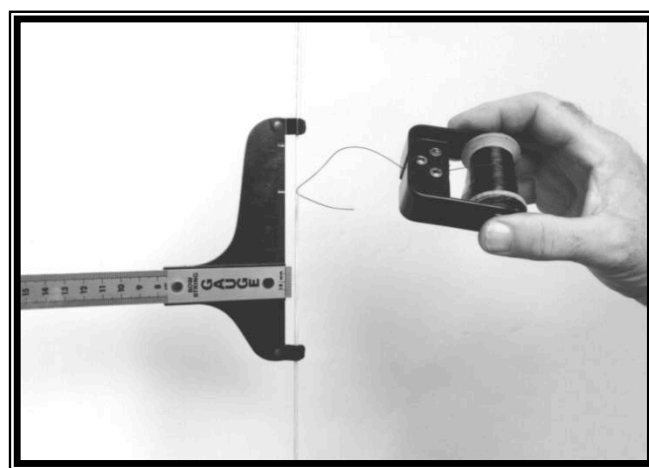

Locate where the string serving will be and fix the start end of the serving material

Serving the required length.

Mark the end of the selected length. When the serving is 1 centimetre shorter than the required length, i.e. about 16 centimetres, depending on individual preference, and finish off the serving exactly the same as the top and bottom servings were finished. Remember the serving gives protection to the string should it contact the bracer during the completion of the shot.

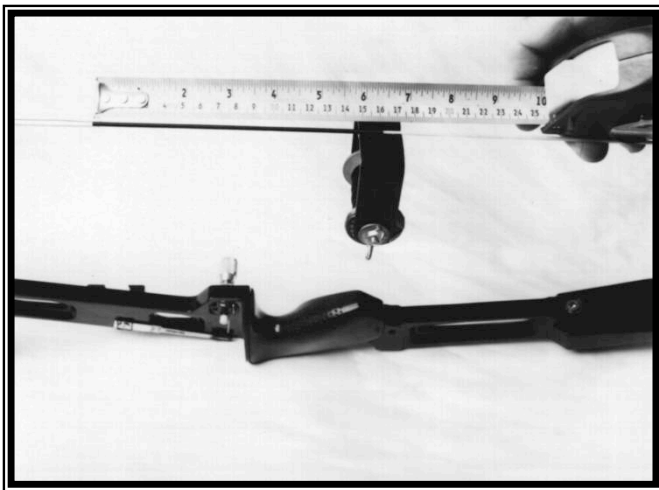

Serving the centre to the correct length

To ensure that the centre serving on the string is running the same way as the other serving done earlier, start the serving on the right and to work toward the left, taking the serving spool over the top of the string and away from you. When the serving is 8 to 10 millimetres short of the required length, pull the required length of serving off the spool to make a loop or bridge and pass the serving device underneath. Reduce the tension of the server before unrolling the end strand. This allows it to detach easily. Make sure that there is one "foot" of the bridge on each side of the string body. Serve back toward the serving through the loop just made. This serving does not need to be tight but the spool must be turned around the string in the same direction as the serving was applied. Make sure that the loop is always kept tight otherwise the serving on the right of the loop will come loose, which will cause a problem when the string is in use.



When this reverse serving is about 8 to 10 millimetres long, about 12 turns, bring the serving on the serving spool out and trap it under the right hand side of the loop. From this point, repeat the process of "Finishing off the serving" through "Cutting off the tail end" described above.

The nock should clip onto the serving with a distinct snap. The arrow should be able to hang from the string and only come off when the string is tapped lightly with a finger.

Nock fit tips:

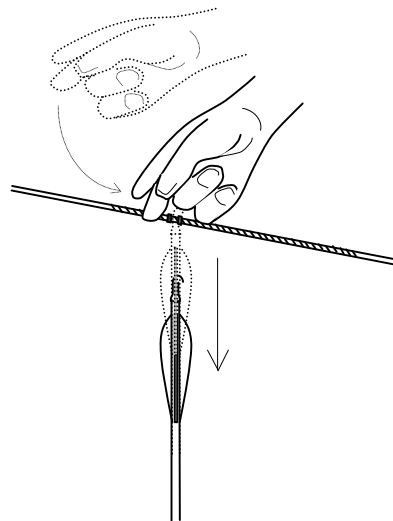

If the nock is too tight on the string then the central serving should be removed and remade with a thinner serving material.

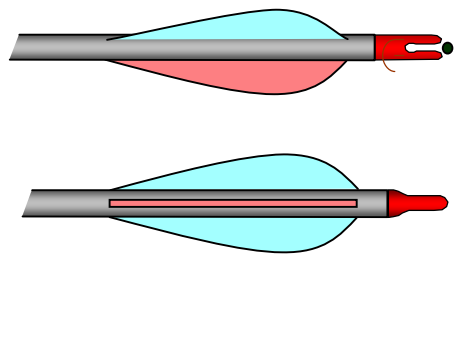

If the nock is too loose the centre of the nocking point can be built up with dental floss or some other similar thread.

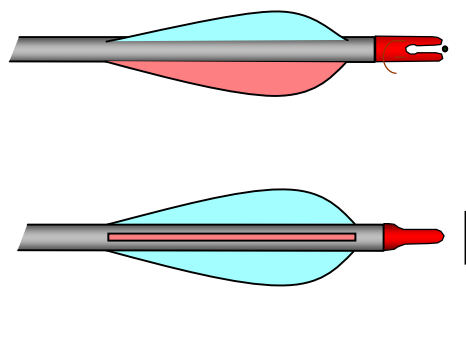

9.12.3. Setting the nocking point:

To fit the nocking point, you must beforehand set the arrow-rest (explained further down) and decide the proper height of the knocking point. See "9.11.5. Initial nocking point setting."

There should be little space either side of the nock.



It is particularly important when shooting with all fingers under the nock to keep the nocking points from squeezing the nock or even bending the arrow down in the vertical plane. The arrow should be able to pivot as shown below.



Nocking points are preferable to nock-sets, which are brass clamps that are crimped onto the string. Nock-sets tend to wear out the finger tab and can injure the archer's forearm if they come into contact.

Testing:

- After each of the first few shooting sessions, re-measure the brace height. It will have most likely decreased.
- Make sure the nocking point is still in the correct position, adjusting it if necessary.

9.13. SELECTING THE BASIC EQUIPMENT:

9.13.1. Kit example

It is difficult to suggest the content of the equipment kit a coach could need, because it depends on the number and profile of the novices. For instance a kit for an elementary school will include lighter bows and softer/shorter arrows than a kit for military

people. The following example is for an average archery club and can be adjusted in characteristics and number of component items to suit the specific needs of a particular group:

12 entry-level bows: 1 RH 70"/ 22# - 1 RH 68"/24# - 1 RH 68"/22# - 1 RH 68"/22# - 1 RH 68"/20# - 1 RH 66"/20# - 1 RH 66"/18# - 1 RH 66"/16# - 1 RH 64"/14# - 1 RH 58"/16# - 1 RH 54"/14# - 1 LH 64"/16# - 1 LH 68"/22#

Accessories for each bow: 3 arrow-rests - 1 entry-level sight with a strong metal extension or one made of plastic - 2 Dacron strings (8 to 10 strands) - 1 extended clicker - 1 long and light stabilizer

For string making and maintenance: 1 spool of string material (Dacron) - 1 spool of serving material - 1 string jig - 1 string server device - 1 Bow square - 1 pair of Nocking Pliers - 1 stick of string wax - Optionally for those who do not want to make the nocking points from a strand: 4 dz. Nocking clamps

Arrows: 12 of 33" - 12 of 32" - 12 of 31" - 18 of 30" - 18 of 29" - 18 of 28" - 18 of 27" - 12 of 26" - 12 of 25" - 12 of 24"

For arrow making and maintenance: 1 x single fletching jig - 1 cement tube - 1 Fast Glue tube - 1 two-part epoxy glue for carbon arrow points - 1 stick of warm melt glue - 6 dozen spare vanes (various colors) - 6 dozen spare nocks (various colors), if nocks of different sizes are being used: 2 dozen per size - 1 dozen point (if points of different sizes are being used: 4 per size)

Archer's equipment: 29 tabs: 5 R/H small, 2 L/H small, 11 R/H medium, 3 L/H medium, 6 R/H large, 2 R/H large - 24 slings: 5 small, 12 medium, 7 large - 6 full-length armguards - 18 regular armguards - 24 ambidextrous quivers - 3 ambidextrous chestguards (one of each size)

Other items: 15 80cm target faces - 1 set of Allen wrenches (9 sizes) - Screwdrivers - Pliers - Self-adhesive tape - Double-sided tape - Measuring tape - Heating source. Optionally: Bow scale

This example of kit does not include any teaching items such as mirrors, elastic bands, elastic strings, string elbow harness...

9.13.2. Selecting a bow

9.13.2.1. Selecting the bows limbs fitting (for take-down bows)

Entry-level bows are not fitted with an accurate limb adaptation system. Some of them even have a simple limb receiver made of plastic. Hence it is advised to check that the limbs are tightly attached to the base of the riser.

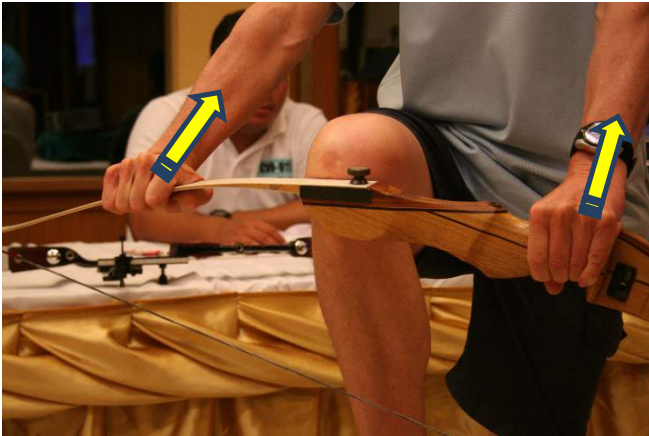

The limbs should move as little as possible.

9.13.2.2. Bow straightness

With the bow strung, stand the bow vertically and position yourself so that you can look from the string side of the bow. Visually the string should line up down the centre of both limbs and the riser. If the string does not line-up down the centre of the limbs and riser at the same time it is highly possible that the limb installation in the riser was wrong, or there is a defect somewhere.

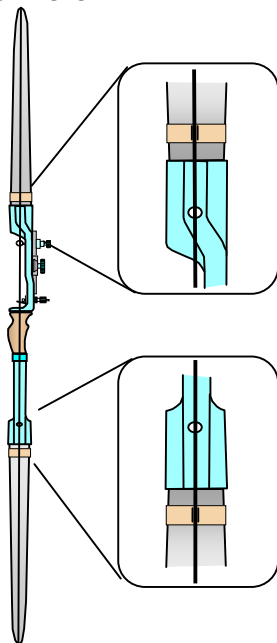

Alternatively you can use the following check that is also related to the centre shot; i.e. the arrow shaft passing in the centre of the riser.

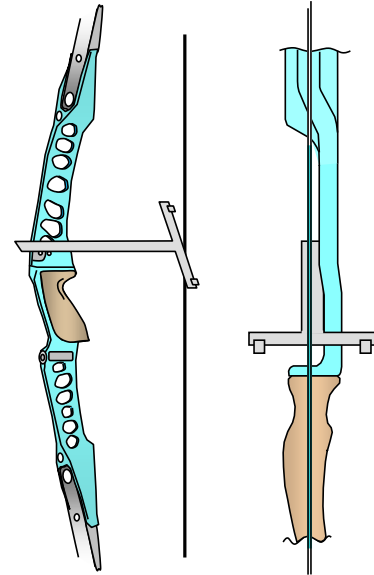

When the bow square is placed against the inside of the bow window at arrow level, the string aligned down the centre of the riser should be seen as parallel to the long edge of the bow square.

For both tests, be accommodating with an entry-level bow!

9.13.2.3. Limb straightness

There are two simple checks to be sure that the limbs are not twisted:

Check #1 - With two arrows lightly wedged between the string and limbs at the ends, as shown below.

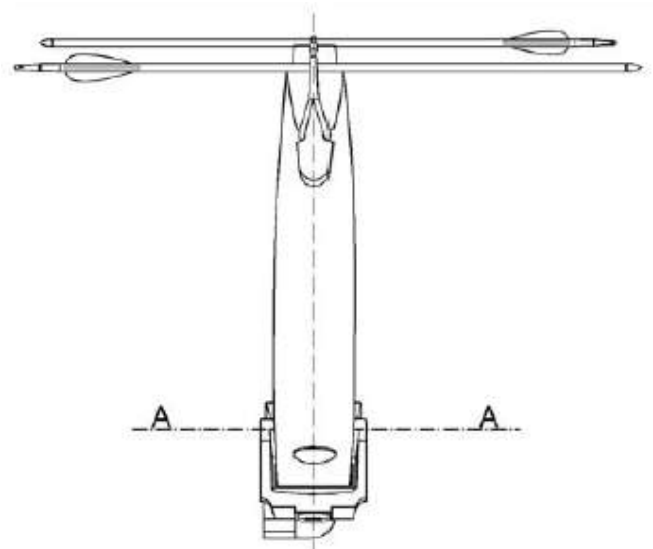

The arrows must be close to parallel.

Check #2 - The symmetrical return of the string into the limb groove. See below.

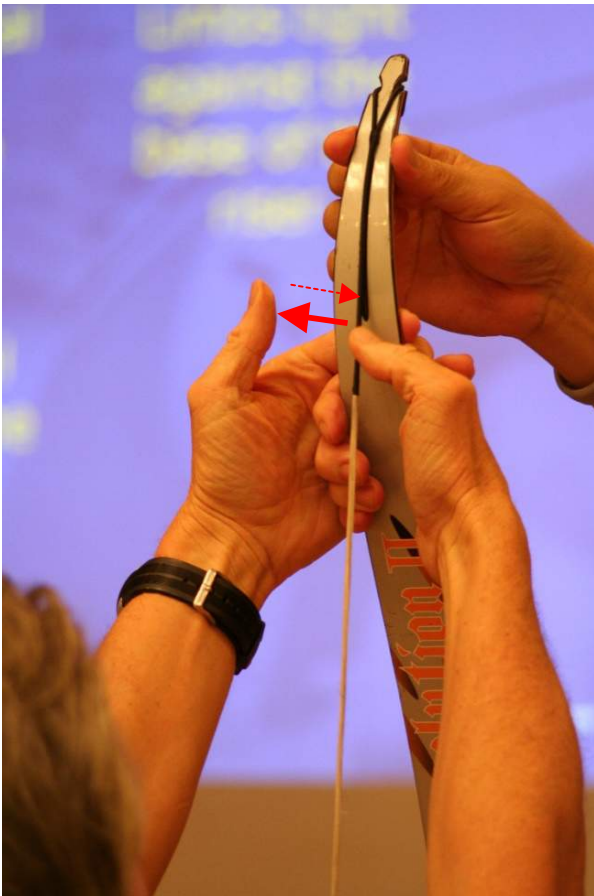

Both tests can be wrong due to lateral movement of the limbs on the riser. Do not expect perfect results on most entry-level bows.

A twisted limb on an entry-level bow can usually be straightened out using the following process:

1. Check in which direction the limb has to be straightened out. Then take it down.
2. Dip a long length of the limb in hot water for at least 5 minutes.
3. With a pair of gloves or pieces of rag, take it out of the water and counter twist it.
4. Hold the counter twist under a cold water tap for at least 30 seconds.
5. Wipe with a rag during the final cooling
6. Put back the limb in place on the riser.
7. Put the string on and redo the control.

You will likely have to redo the above process a few times before getting the limb straight.

9.13.2.4. Vertical string resistance

If you are undecided between some different models of bows that are similar in height and weight, you can make your choice using the following comparison.



Block the riser, and move the string up and down. The model showing the best vertical resistance should have your preference. It will allow better vertical groups from the novice, by being more forgiving with the little changes of pressure at the bow hand and string grip.

9.13.2.5. Tiller

For a bow to be efficient both limbs have to work in unison. Upon the separation of the arrow from the string:

- If the top limb is ahead of the bottom one, the arrow exits pointing downward
 - If the bottom limb is ahead of the top one, the arrow exits pointing upward
- In both cases, the arrow will "porpoise".

To generate the synchronisation of the two limbs, the makers usually produce the bottom limb a little heavier than the top one. This weight difference distorts the geometry of the bow as reported in the illustration below.

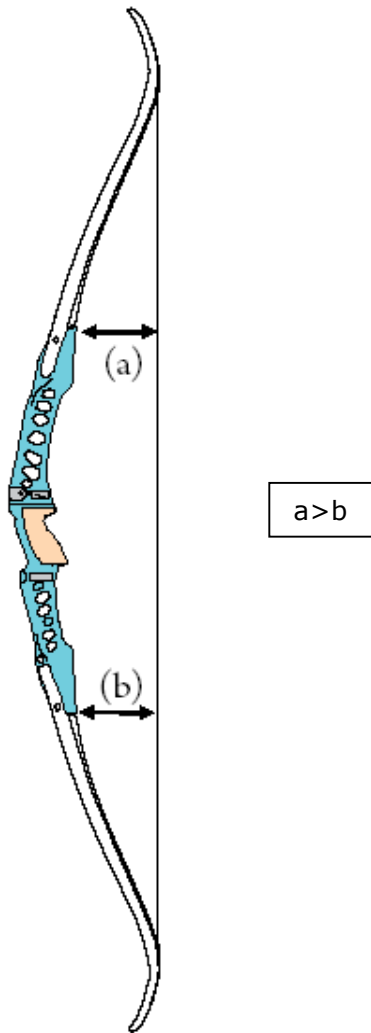

that, usually, you cannot adjust the tiller. Hence just use the original one and set the nocking point (the lower part of the nock) about 1cm above square. Further details on nocking point height are covered in the section 9.11.5.

9.13.3. Selecting and fitting the arrow rest:

There are many models of arrow rests available. For entry-level archery, plastic rests work best because they are more forgiving than those with a metal arm on which the arrow rests.



A popular and satisfactory type of rest

To extend the life of such a rest, cut the curve end at the level of the Red line.

Hunting-type rests made of dark rubber-like plastic are more resistant, but the arrow usually rubs on these rests and after a while the fletchings become marked or damaged.



Because most entry-level bows are not fitted with a pressure button, the arrow-rest must have a lateral spacer for the arrow.

When the arrow rest is used in association with a pressure button, make sure that the hole in the arrow rest fits exactly over the corresponding hole in the riser during installation. If these two holes are not lined up the arrow rest may foul the pressure button plunger negating the efficiency of the button's operation.

The reason for this difference is that the archer applies more pressure to the lower part of the bow, since the bow hand and string grip are below the centre of the bow (particularly with 3 fingers below the arrow). Hence the bottom limb is stressed more than the top one, and has more distance to run back. This is one of the reasons for a high nocking point (to decrease the stress on the bottom limb, and stress a little more the top one). To cover this longer distance, the bottom limb must return faster back to the original position than the top one. The normal difference between the measures of distance (a) and distance (b) is a little less than half a centimetre for a bow used with one finger above and two fingers below the arrow.

The first challenge with setting tiller on an entry-level bow, is that it can be used with different string grips (3 fingers at about 4cm below the nock, 3 fingers just below the nock, 1 finger above and 2 fingers below the nock). Due to this difficulty, an "intermediate" tiller that is higher than the manufacturers' recommendation should be set: the distance (a) about ¾ cm greater than the distance (b). But the second challenge with an entry-level bow is

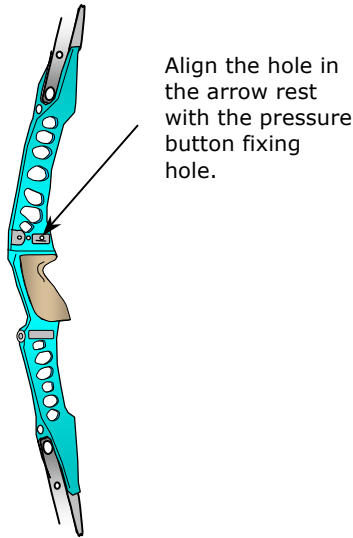

Align the hole in the arrow rest with the pressure button fixing hole.

Also, the arrow rest should be installed so that the arrow shaft is centred on the plunger button (in height).

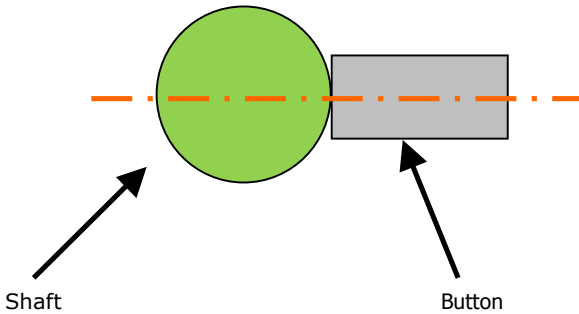

If you decide to use a flipper-rest or any kind of plastic rest with a straight/horizontal rest surface for the arrow, make sure that the arrow rest arm does not slope down away from the bow. If it does, the arrow may slip down the arm and fall off the rest during the draw.

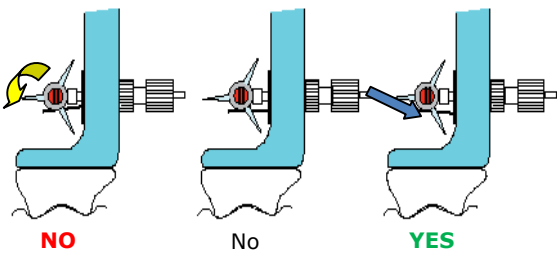

The arrow rest arm should be sloping slightly in toward the bow. This will help keep the arrow up against the pressure button or riser during the draw.

9.13.4. Pressure button:

A pressure button, sometimes called a "plunger button," fits into the riser allowing the arrow to rest against the small end, which acts like a shock absorber for the arrow.

If the riser has the facility to fit a pressure button, install one as it could allow for better arrow flight.

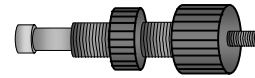

Refer to the WA level 2 coaching manual to set it properly. On an entry level bow, strive to set up the button as follows:

- The pressure should be in the middle range of the stiffness of the inner spring
- The tip of the button should be such that the arrow shaft is in the centre of the bow. On an entry-level bow, the end of the shaft close to the point, can be very slightly out (left for a R/H archer)

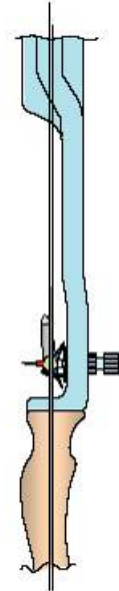

9.13.5. Initial nocking point setting:

Using a bow square (also called string or bow gauge) clipped to the string and lightly resting on the arrow rest, the lower part of the nock should be above square with the rest arm:

- Approximately 10 mm higher if the bow will be used unsighted, with the archer's three fingers about 4 cm below the nock.
- 5 to 6 mm high if the string will be drawn with one finger above the nock and two fingers below the nock.

If the bow is to be used with various students using both string grips, it is better to use the higher 10mm nocking point position, or maybe an average measure of 8mm on the string. With this setting, the back of the arrow will pass above the arrow-rest, reducing the risk of the fletchings hitting it and causing the arrow to have an inconsistent flight.

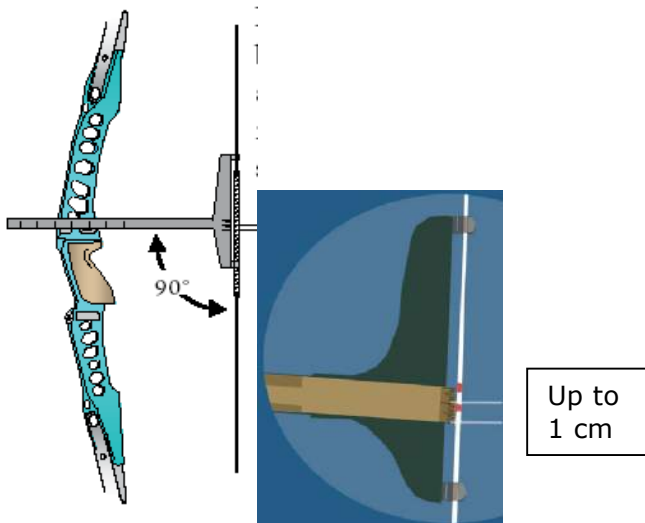

9.13.6. Arrow selection

In section 9.3. several suggestions have been made regarding the selection of the arrow material, spine, length and nock. Now some words about the fletching.

Larger fletchings may cause some problems in getting them to clear the arrow shelf or the vertical part of the riser during the initial stages of the arrow flight. On the other hand, smaller fletchings may not give sufficient stability to the arrow during its flight.

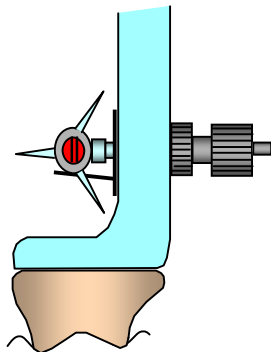

It is better to use standard sizes:

- Length (2 3/4 "), or a little longer (up to 3")
- Height 1/2"

Note: Big and colourful fletching make finding arrows a lot easier when they miss the target and are in the grass!

9.13.7. Fitting the sight:

Affix the sight such that the sight moves vertically along the bowstring. A simple test consists of moving the sight pin from the top to the bottom of the sight rack and comparing its position with respect to the string at both locations to ensure the rack is lined up with the string.

For the first shots, have the centre of the sight ring aligned on the string as shown below:

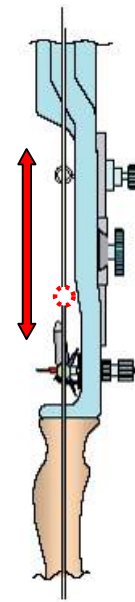

9.13.8. Clicker:

A clicker is a draw length check for the archer, when the novice has good form and their draw length is consistent the coach may invite them to fit a clicker to their bow. The clicker is a tool that helps the archer expand the upper torso at full draw and, hopefully, release during this expansion.

Clicker (draw length check)

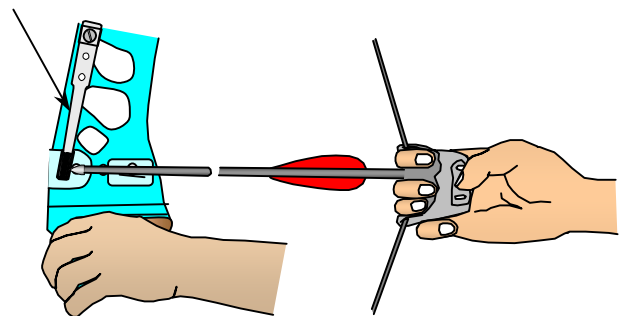

Using a fully adjustable clicker makes it easier to accommodate any draw length change that the novice may encounter as they develop.

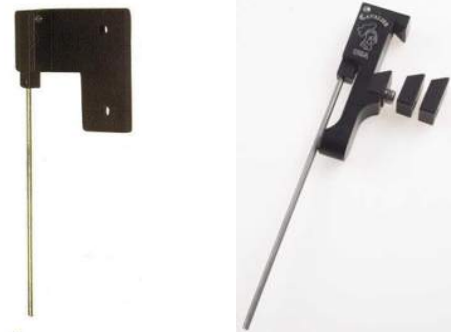

The extended clicker on the left is fitted under the sight base, while the one on the right is set on the sight bar; hence it is more for level 2.

9.13.9. Stabilisation:

The drawing below shows a bow with an example of a stabiliser setup for an advanced archer.

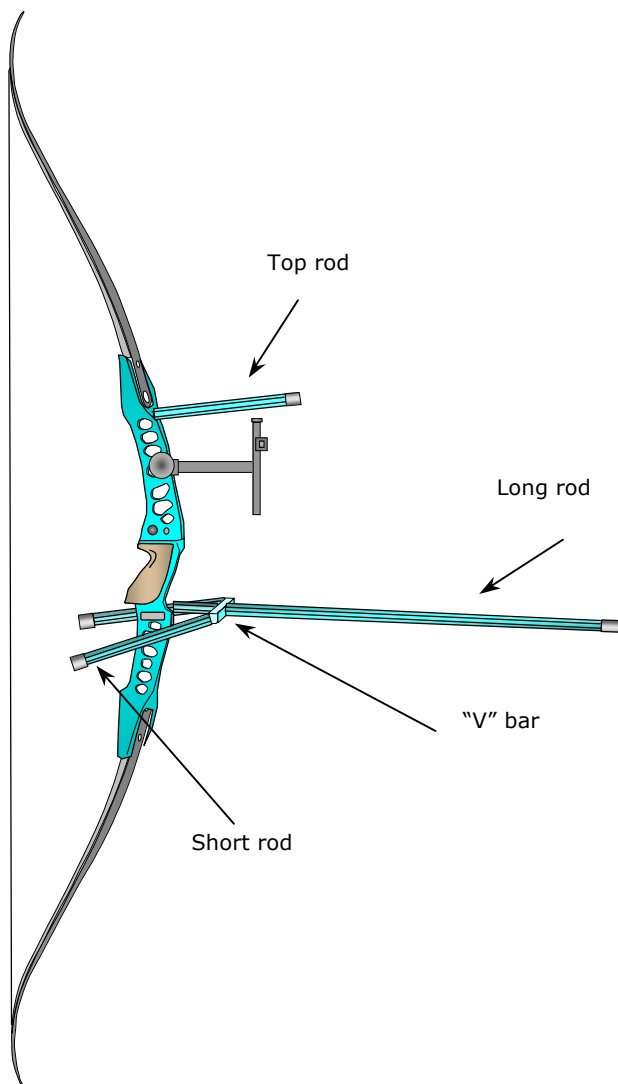

9.14. HOW TO SET UP AN ARCHERY RANGE

WA has published a specific document on this subject. It can be found at:

http://www.worldarchery.org/Portals/1/Documents/Development/Documents/How_to_make_an_Archery_Range.pdf

It is quite common to start with fitting a "long-rod". It is likely that other accessories will be added as the novice progresses to higher levels of competence. The long rod alone helps to:

- Maintain the bow's orientation during the propelling phase;
- Minimize the hit of the string on the bow forearm;
- Avoid the bow leaning backward after release and hitting the head of the novice;
- Better bow hand relaxation (wrist bent down), particularly after the release when the bow moves forward and down.

Note that each attachment that is added will make the bow heavier.
